

m o o o i

Aldora Vis a Vis

CRISTINA CELESTINO



The Aldora Vis a Vis, designed by Cristina Celestino, adds a touch of natural charm to any commercial or private space. The sculptural backrests are inspired by Milanese decadence and graceful calla lilies. Its dual-sided design offers functional elegance, making it perfect as a freestanding seater. Discover versatility with left/right setups and choose from an array of fabrics and leathers for a personalised touch. Aldora Vis a Vis will invite conversations, engage in style, and elevate any space. The Aldora Vis a Vis is also available as a sofa and chaise longue. Configure the Aldora Vis a Vis to your personal tastes with the online configurator. Choose from a wide selection of fabrics and leathers and discover what it looks like with our AR tool.

Detailing

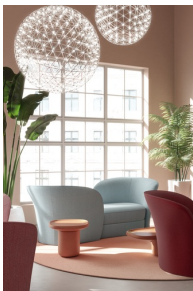

Aldora Vis a Vis is perfect for offices and waiting areas. This dual-sided, freestanding design offers functional elegance.

Aldora Vis a Vis / Left

Dimensions

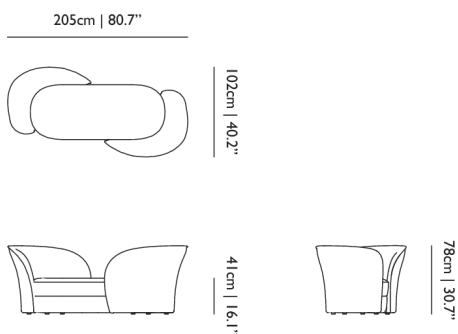

Product

WIDTH 205cm | 80.7"
HEIGHT 78cm | 30.7"
DEPTH 102cm | 40.2"
WEIGHT NETTO 46kg | 101.4lbs

Packaging

WIDTH 85cm | 33.5"
HEIGHT 84cm | 33.1"
CUBAGE 1.48m³ | 52.19ft³
LENGTH 207cm | 81.5"
WEIGHT 59.5kg | 131.17lbs

Technical

MATERIAL

Wood and steel frame, foam over steel springs

Aldora Vis a Vis / Right

Dimensions

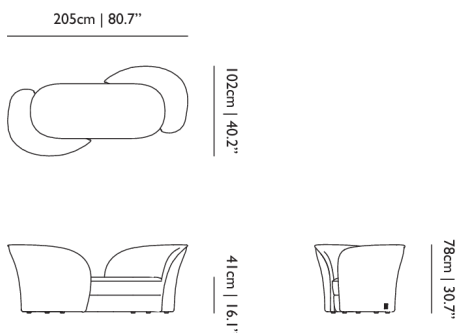

Product

WIDTH 205cm | 80.7"
HEIGHT 78cm | 30.7"
DEPTH 102cm | 40.2"
WEIGHT NETTO 46kg | 101.4lbs

Packaging

WIDTH 85cm | 33.5"
HEIGHT 84cm | 33.1"
CUBAGE 1.48m³ | 52.19ft³
LENGTH 207cm | 81.5"
WEIGHT 59.5kg | 131.17lbs

Technical

MATERIAL

Wood and steel frame, foam over steel springs

Upholstery

ABBRACCI (available in 5 colours)



COMPOSITION
100% PES

ABRASION
30000 martindale
lightfastness 3 - 4
pilling 5

FIRE RESISTANCE
BS 5852 - Ignition source
0 (Cigarette)
BS 5852 - Ignition source
1 (Match flame equivalent)
EN 1021-1 (Cigarette)
EN 1021-2 (Match)
TB 117-2013

ARDA (available in 12 colours)



ABRASION
50000 martindale
lightfastness 5 - 6
pilling 4 - 5

FIRE RESISTANCE
BS 5852 - Ignition source
0 (Cigarette)
BS 5852 - Ignition source
5 (Crib 5)
BS 5852 - Ignition source
1 (Match flame equivalent)
EN 1021-1 (Cigarette)
EN 1021-2 (Match)
TB 117-2013
EU Ecolabel

DIVINA 3 (available in 56 colours)

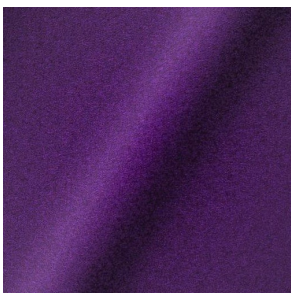

COMPOSITION
100% WO

ABRASION
45000 martindale
lightfastness 7
pilling 3

FIRE RESISTANCE
BS 5852 - Ignition source
0 (Cigarette)
BS 5852 - Ignition source
5 (Crib 5)
BS 5852 - Ignition source
1 (Match flame equivalent)
EN 1021-1 (Cigarette)
EN 1021-2 (Match)
TB 117-2013
EU Ecolabel

DIVINA MD (available in 27 colours)



COMPOSITION
100% WO

ABRASION
45000 martindale
lightfastness 6
pilling 3

FIRE RESISTANCE
BS 5852 - Ignition source
0 (Cigarette)
BS 5852 - Ignition source
5 (Crib 5)
BS 5852 - Ignition source
1 (Match flame equivalent)
EN 1021-1 (Cigarette)
EN 1021-2 (Match)
EU Ecolabel

DIVINA MELANGE 3 (available in 49 colours)



COMPOSITION
100% WO

ABRASION
45000 martindale
lightfastness 6 - 7
pilling 3

FIRE RESISTANCE
BS 5852 - Ignition source
0 (Cigarette)
BS 5852 - Ignition source
5 (Crib 5)
BS 5852 - Ignition source
1 (Match flame equivalent)
EN 1021-1 (Cigarette)
EN 1021-2 (Match)
TB 117-2013
EU Ecolabel

Bearded Leopard (available in 3 colours)

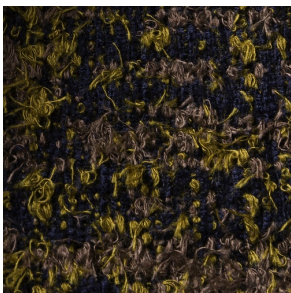

COMPOSITION
77% CV, 15% PES, 7% CO,
1% PA

ABRASION
15000 martindale
lightfastness 4 - 6
pilling 4

Calligraphy Bird (available in 4 colours)



COMPOSITION

64% CV, 21% PES, 15%
CO

ABRASION

50000 martindale
lightfastness 4 - 6
pilling 5

Dodo Pavone (available in 3 colours)



COMPOSITION

12% CO, 88% PES

ABRASION

40000 martindale
lightfastness 5
pilling 4 - 5

Memento Moooi Medley (available in 1 colours)



COMPOSITION

100% PES

ABRASION

50000 martindale
lightfastness 4 - 6
pilling 5

FIRE RESISTANCE

EN 1021-1 (Cigarette)
EN 1021-2 (Match)
TB 117-2013

Menagerie of Extinct Animals (available in 2 colours)



COMPOSITION

100% PES

ABRASION

50000 martindale
lightfastness 4 - 6
pilling 5

FIRE RESISTANCE

EN 1021-1 (Cigarette)
EN 1021-2 (Match)
TB 117-2013

Rendezvous Tokyo Blue (available in 1 colours)



COMPOSITION
100% PES

ABRASION
50000 martindale
lightfastness 4 - 6
pilling 5

Blushing Sloth Melange Mohair (available in 1 colours)



COMPOSITION
85% WV, 15% WM

ABRASION
15000 martindale
lightfastness 4 - 6
pilling 2 - 3

Blushing Sloth Woolly Mohair (available in 1 colours)



COMPOSITION
24% PES, 15% PA, 8% CO,
24% WM, 29% WV

ABRASION
40000 martindale
lightfastness 4 - 6
pilling 3 - 4

FIORD (available in 39 colours)



COMPOSITION
92% WV, 8% PA

ABRASION
60000 martindale
lightfastness 6
pilling 4 - 5

FIRE RESISTANCE
EN 1021-1 (Cigarette)
EN 1021-2 (Match)
BS 5852 - Ignition source
0 (Cigarette)
BS 5852 - Ignition source
1 (Match flame equivalent)

HALLINGDAL 65 (available in 58 colours)

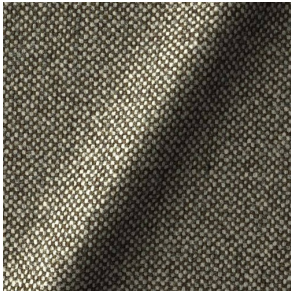

COMPOSITION

30% CV, 70% WV

ABRASION

100000 martindale
lightfastness 7
pilling 3 - 4

FIRE RESISTANCE

BS 5852 - Ignition source
0 (Cigarette)
BS 5852 - Ignition source
5 (Crib 5)
BS 5852 - Ignition source
1 (Match flame equivalent)
EN 1021-1 (Cigarette)
EN 1021-2 (Match)
TB 117-2013
EU Ecolabel

JUSTO (available in 10 colours)



COMPOSITION

15% CO, 35% PC, 10% PA,
40% CV

ABRASION

50000 martindale
lightfastness 5
pilling 4

FIRE RESISTANCE

EN 1021-1 (Cigarette)
EN 1021-2 (Match)
TB 117-2013

LISCIO (available in 11 colours)

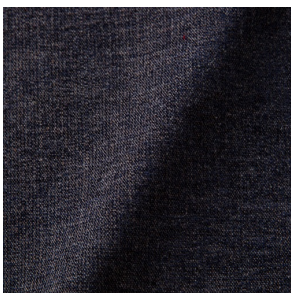

COMPOSITION

35% WO, 35% CV, 21%
CO, 9% PA

ABRASION

30000 martindale
lightfastness 4 - 6
pilling 4

FIRE RESISTANCE

TB 117-2013

MOSAIC 2 (available in 15 colours)

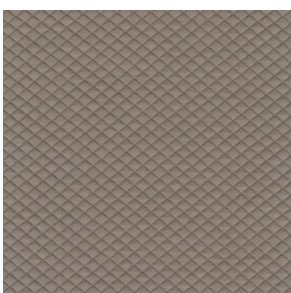

COMPOSITION

58% PES, 27% WV, 9% PA,
6% EA

ABRASION

100000 martindale
lightfastness 6 - 7
pilling 4 - 5

PALETTE (available in 24 colours)

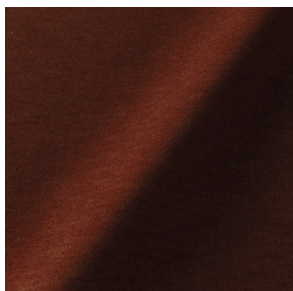

COMPOSITION

42% CO, 29% WO, 29%
TL

ABRASION

45000 martindale
lightfastness 4 - 5
pilling 3 - 3

FIRE RESISTANCE

BS 5852 - Ignition source
0 (Cigarette)
TB 117-2013
BS 5852 - Ignition source
5 (Crib 5)

REMIX 3 (available in 53 colours)



COMPOSITION

10% PA, 90% WV

ABRASION

100000 martindale
lightfastness 5
pilling 4

SAVANNE (available in 3 colours)

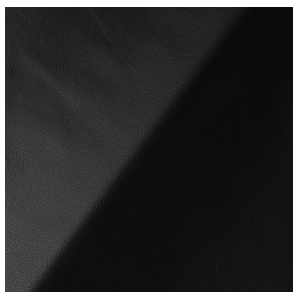

FIRE RESISTANCE

EN 1021-1 (Cigarette)
EN 1021-2 (Match)
TB 117-2013
OEKO-TEX

SHADE (available in 6 colours)

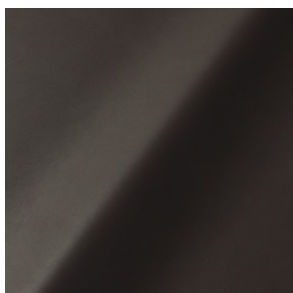

ABRASION

lightfastness 3 - 4

FIRE RESISTANCE

EN 1021-1 (Cigarette)
EN 1021-2 (Match)
TB 117-2013

SOLIS (available in 9 colours)



COMPOSITION

60% WO, 30% PES, 2%
PA, 3% PC

ABRASION

40000 martindale
lightfastness 5
pilling 3 - 4

FIRE RESISTANCE

EN 1021-1 (Cigarette)
EN 1021-2 (Match)
TB 117-2013

SPECTRUM (available in 11 colours)

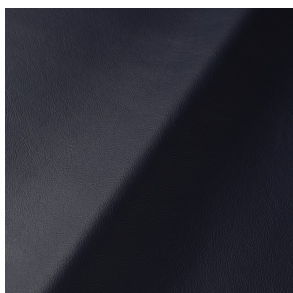

ABRASION

lightfastness 6 - 6

FIRE RESISTANCE

EN 1021-1 (Cigarette)
EN 1021-2 (Match)
TB 117-2013
OEKO-TEX

SPRINKLES (available in 23 colours)

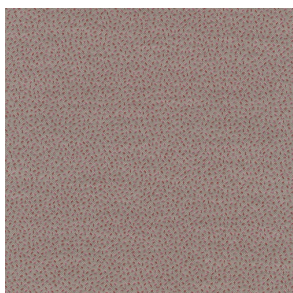

ABRASION

80000 martindale
lightfastness 7
pilling 4

FIRE RESISTANCE

EU Ecolabel
BS 5852 - Ignition source
0 (Cigarette)
BS 5852 - Ignition source
5 (Crib 5)
BS 5852 - Ignition source
1 (Match flame equivalent)
EN 1021-1 (Cigarette)
EN 1021-2 (Match)
TB 117-2013

STEELCUT TRIO 3 (available in 54 colours)

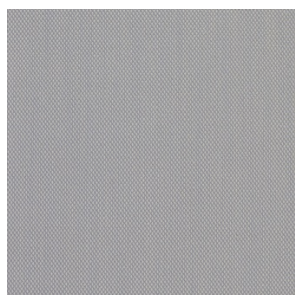

COMPOSITION

90% WV, 10% PA

ABRASION

100000 martindale
lightfastness 5
pilling 4

FIRE RESISTANCE

BS 5852 - Ignition source
0 (Cigarette)
BS 5852 - Ignition source
1 (Match flame equivalent)
EN 1021-1 (Cigarette)
EN 1021-2 (Match)
EU Ecolabel

ULTRA (available in 6 colours)

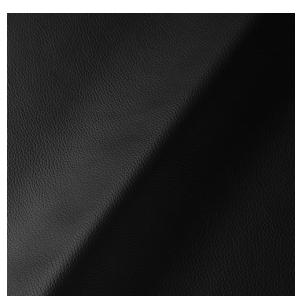

ABRASION

lightfastness 6 - 7

FIRE RESISTANCE

EN 1021-1 (Cigarette)
EN 1021-2 (Match)
TB 117-2013
ANSI/BIFMA M7.1 (Total
Volatile Organic
Compounds)

VESPER (available in 8 colours)



COMPOSITION

10% CO, 40% LI, 10% PA,
10% PES, 30% CV

ABRASION

40000 martindale
lightfastness 5
pilling 4

FIRE RESISTANCE

EN 1021-1 (Cigarette)
EN 1021-2 (Match)
TB 117-2013
