

m o o o i[®]



Meshmatics Chandelier Small

by Rick Tegelaar

The sophisticated Meshmatics Chandelier is now available in two sizes. The Meshmatics Chandelier Small is made from the same material and in the same way as its elegant big brother, of humble wire netting and with a machine that, with a set of tools, models it with perfect accuracy. The full potential of the material is then stretched and captured within three smaller layers of beauty.

Designer

Rick Tegelaar

Year of design

2019

Technical (ce)



Input voltage:

220-240V ~ 50-60Hz

Power consumption:

Max 12w

Colour temperature:

2700k

Dimmable:

Yes (external)

Lumen:

665

Cable length:

4 or 10m

Cable colour:

Transparent

Canopy:

Steel pebble

m o o o i[®]

Technical (ul)

**Input voltage:**

120V ~ 50-60Hz

Power consumption:

Max 9w

Colour temperature:

2700k

Dimmable:

Yes (external)

Lumen:

665

Cable length:

4 or 10m

Cable colour:

Transparent

Canopy:

Steel pebble

Recommended dimmer specs

For fluent dimming behaviour we advise a dimmer that is compatible with the following specs:

Transformer type: Electronic Low Voltage (ELV)

Load type: Capacitive load (C-Type)

Dimmer type: Trailing edge / Reverse phase

Please note the functioning of the dimmer and the power supply combination can never be predicted, it always needs to be tested in practice.

m o o o i[®]

Dimensions

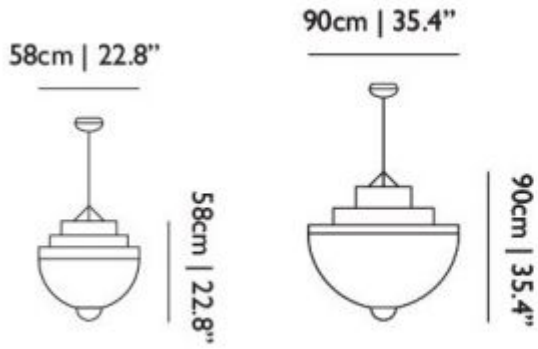

Packaging Dimensions

Meshmatics Chandelier Small

H 80 cm | 31.49"

W 73 cm | 28.74"

L 73 cm | 28.74"

Total shipping weight:

5KG | 11.02lbs