

m o o o i[®]

m o o o i[®]



Container Table I0636

by Marcel Wanders

The Container Table concept is a fully versatile system that has endless composition possibilities to fit in any space. With combinations to suit your home, office or public space the Container Table can certainly exceed any requirements.

Designer	Marcel Wanders
Year of design	2001
Material	Container Foot: PE, Top: HPL, LPL, Laquered Wood, Stained Wood, Linoleum

Foot colours

Foot Colours



Light Grey, Ral 7035



Terracotta, Ral 2013



Concrete, Ral 7013 +
7006



Black, Ral 9017

The container Tops are available in the following materials and colours:



HPL, A flat panel based on thermosetting resins, homogeneously reinforced with woodfibres and manufactured under high pressure and at high temperatures:

Thickness top 1.2cm | 0.5"

Also for outdoor use

Available in white, black and light grey. The trim is always black.



Oak veneer, stained and lacquered:

Thickness top 4cm | 1.6"

For indoor use only

Available in the 6 Moooi stain colours, and 25 Moooi Ral Colours

m o o o i[®]



Linoak:

Thickness top, 4cm | 1.6"

For indoor use only

The solid oak edge is available in the 6 Moooi stain colours, the linoleum centre is available in Mauve, Pewter and Nero.

The container feet are available in the following shapes and colours



Classic - In colours: White, Black, Light Grey, Terracotta, Concrete



New Antiques - In colours: White, Black, Light Grey, Terracotta, Concrete





Bodhi Cover - In colours: Black, Cinnamon, Grey, Natural Oil, Wenge, White Wash

Container General

The container table top range all attached to the container foot in the same way. The container concept is that sand, pebbles or water can be added to the foot to give it strength and stability. Water must always be treated with an anti-algae additive to prevent the water from becoming stale. There are Hex-bolts on the underside of each table which align with equally spaced holes in the container foot.

Container Table 10636 - 10638 options

CONTAINER FAMILY		Top				FOOT	bar table
Shape	L	W	HPL	Wood	Linoak	 Classic	10636 106cm 41.7" x 36cm 14.2"
						 Bodhi	10636 106cm 41.7" x 36cm 14.2"
						 New Antiques	10638 106cm 41.7" x 38cm 15"
						<i>Number of feet required</i>	
Round	∅	70cm 27.6"	x	x	x		
Square	70cm 27.6"	70cm 27.6"	x	x	x		
Square	80cm 31.5"	80cm 31.5"	x	x	x		

HPL colours

HPL tops are available in the following colours



Black

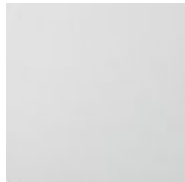

Grey

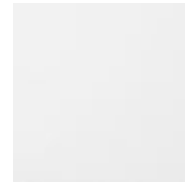

White

Container table top - Linoak

The center of the Linoak top is made of linoleum, and available in the following colours. The solid oak edge is available in one of the 6 moovi stain colours.

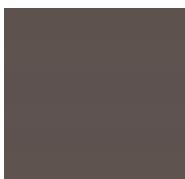

mauve



nero



pewter

Wood Stained Colours for Container Table top, Bodhi covers & Zio family



White Wash



Wenge

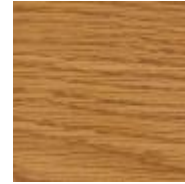

Natural Oil

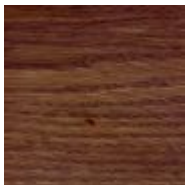

Cinnamon



Black Stained

Container Table Top - Ral Colours

Available RAL Colours:

1004 1013 1023 1027 2000 2002 2004 3012 3015 5003 5008 5024 6010 6021 7001 7011 7035 7044 8001
8014 8016 9005 9010 9016 3003



RAL 1004



RAL 1013



RAL 1023



RAL 2000



RAL 2002



RAL 2004

m o o o i[®]



RAL 3012



RAL 3015



RAL 5003



RAL 5024



RAL 6010



RAL 6021



RAL 7011

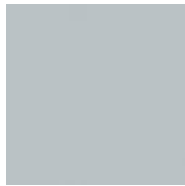

RAL 7035



RAL 7044



RAL 8014



RAL 8016



RAL 9005

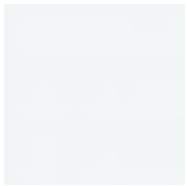

RAL 9016

cleaning instructions

Moooi recommends using a good furniture polish and a soft cloth. Apply generously in layers to the surface and use the cloth to shine. Do not use abrasive fabrics, gently remove tough stains with warm water and a trusted multi-surface cleaner.



packaging I0030 and I0638 feet

Bodhi Cover I0030

H 95 cm | 37,4"

W 20 cm | 7,9"

D 20 cm | 7,9"

Colli 1/1

Product weight:

7,7 KG | 17 lb

With packaging:

8,7 KG | 19,2 lb

Container Table Foot I0636

H 110 cm | 43,3"

W 42 cm | 12,6"

D 42 cm | 12,6"

Colli 1/1

Product weight:

5,5 KG | 12,1 lb

With packaging:

6,5 KG | 14,3 lb

Container New Antiques I0638

H 109 cm | 42,9"

W 41 cm | 16,1"

D 41 cm | 16,1"

Colli 1/1

Product weight:

10 KG | 22 lb

With packaging:

11 KG | 24,3 lb

Packaging 70x 70 and round 70 tops

HPL

H 3 cm | 1.2"

W 71 cm | 27.9"

D 71 cm | 27.9"

70 x 70

Colli 1

Product weight:

8,2 KG | 17,6 lb

With packaging:

10 KG | 22 lb

70Ø

Colli 1

Product weight:

6,4 KG | 14,1 lb

With packaging:

8,4 KG | 18,5 lb

LPL

H 4 cm | 1.6"

W 71 cm | 27.9"

D 71 cm | 27.9"

70 x 70

Colli 1

Product weight:

9,3 KG | 20,5 lb

With packaging:

11,3 KG | 25 lb

70Ø

Colli 1

Product weight:

7,3 KG | 16 lb

With packaging:

9,3 KG | 20,5 lb

Wood & Linoak

H 8 cm | 3.1"

W 76 cm | 29.9"

D 76 cm | 29.9"

70 x 70

Colli 1

Product weight:

15,6 KG | 34,4 lb

With packaging:

17,6 KG | 38,8 lb

70Ø

Colli 1

Product weight:

12,3 KG | 27,1 lb

With packaging:

14,3 KG | 31,5 lb

Packaging 80x80 tops

HPL
H 3 cm | 1.2"
W 81 cm | 31.8"
D 81 cm | 31.8"
Colli 1
Product weight:
10,7 KG | 23,6 lb
With packaging:
13,2 KG | 29,1 lb

Wood & Linoak
H 8 cm | 3.1"
W 86 cm | 33.8"
D 86 cm | 33.8"
Colli 1
Product weight:
20,5 KG | 45,2 lb
With packaging:
23 KG | 50,7 lb

Dimensions

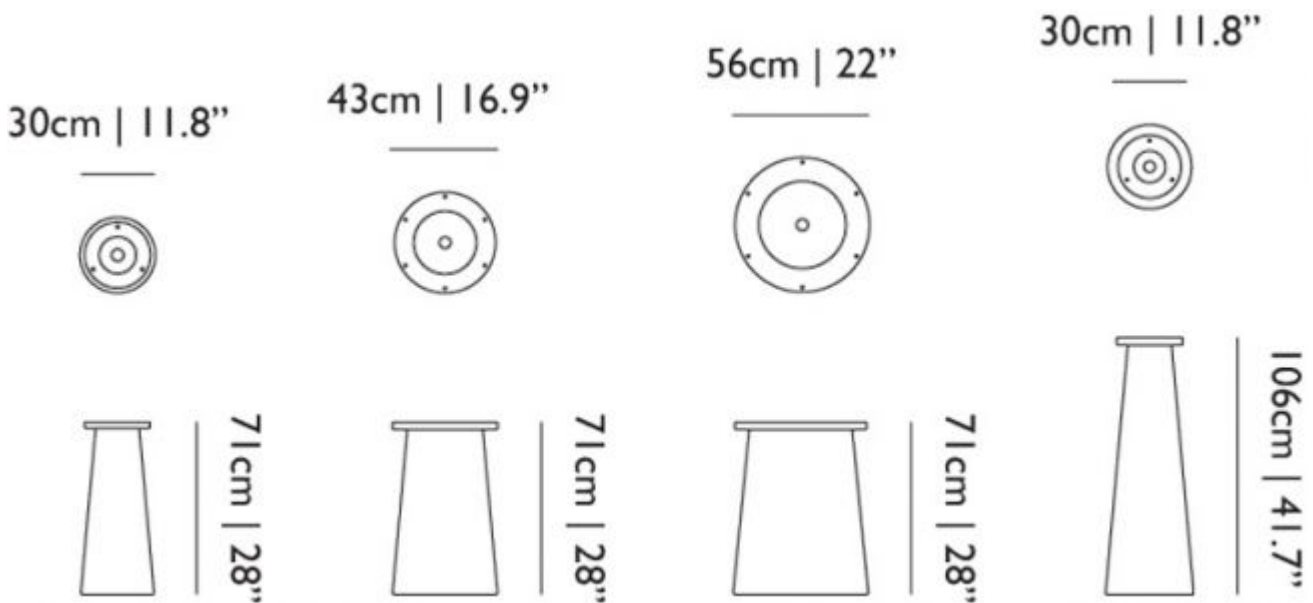

m o o i[®]

Dimensions New Antiques



71 cm | 28"

32 cm | 12.6"



71 cm | 28"

43 cm | 16.9"



71 cm | 28"

56 cm | 22"



106 cm | 41.8"

38 cm | 15"