

m o o o i[®]



Bart Sofa & Armchair

by Moooi Works | Bart Schilder

Have you ever thought of bringing a touch of grandeur to your home, without conveying the firm austerity of real antiques?

Designer	Moooi Works
Year of design	2012
Material	Wooden frame covered in foam and dacron, the seat cushion is made in foam.

detailing

Bart sofa is produced with removable covers for the seat cushion and all pillows (please check per category).

There are 3 compositions available; SOFA (low seat), CANAPE (active seat) and DAYBED.

The Daybed comes with a set of pillows in matching upholstery.

technical

The Bart sofa is constructed from a wood frame covered in foam and dacron, the seat cushion is made in foam and removable.

Bart sofa is produced with removable covers for the seat cushion and all pillows (please check per category).

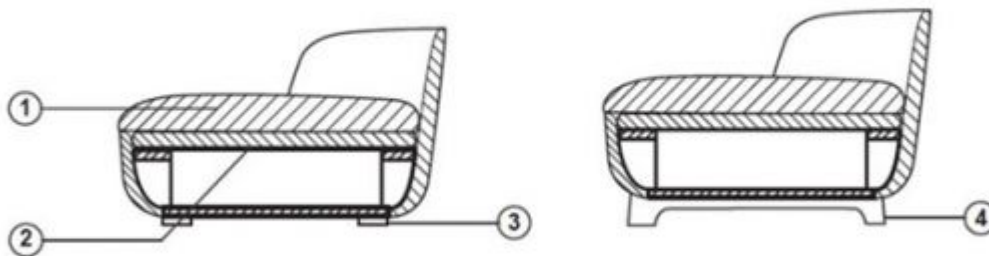

1. Multiple density fire retardant foam composition + dacron on wood frame
 2. Elastic straps fixed on the wood base
 3. Plastic glider feet
 4. Solid wood legs (for Canape)
-

m o o o i[®]

Abbracci

composition

100% pl

abrasion

50.000 martindale

lightfastness 4

firetest

FR BS5852 0/1

EN1021 I&2

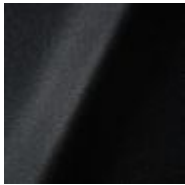

Abbracci
Black



Abbracci
Brown



Abbracci
Grey

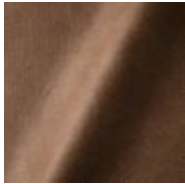

Abbracci
Taupe

Divina 3

Composition

100% new wool

Martindale

45.000

Pilling

3

Lightfastness

7

m o o o i[®]

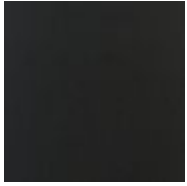

Divina 3
Black



Divina 3
Blue

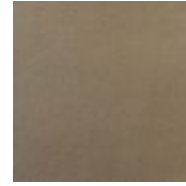

Divina 3
Brown

Divina Melange 2

Composition

100% New wool

Durability

45.000 Martindale

Pilling

3

Lightfastness

6-7

Sustainability

Natural fibres / Sustainable resource



Divina Melange
120



Divina Melange
170



Divina Melange
180



Divina Melange
260

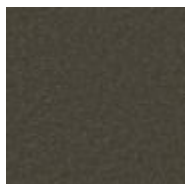

Divina Melange
280



Divina Melange
421



Divina Melange
521

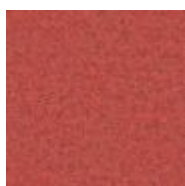

Divina Melange
531

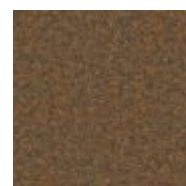

Divina Melange
571

m o o o i[®]



Divina Melange
620



Divina Melange
631

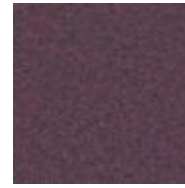

Divina Melange
671



Divina Melange
721



Divina Melange
731



Divina Melange
771



Divina Melange
871



Divina Melange
920

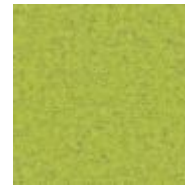

Divina Melange
931

Justo

composition

15% CO, 35% PC, 10% PL, 40% VI

abrasion

50.000 Martindale rubs, EN ISO 12947

lightfastness

Note 5, EN ISO 105-B02

fire test

EN 1021-1/2

US. Cal. Bull. 117-2013

NFPA 260

Upon request, with treatment:

BS5852 part 1

BS5852 crib 5

m o o o i[®]

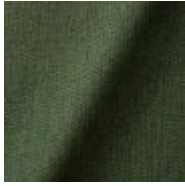

Justo
Alge

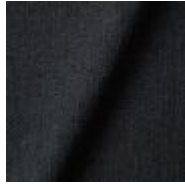

Justo
Bazalt



Justo
Bred



Justo
Hinde



Justo
Lyse



Justo
Muse



Justo
Sennep



Justo
Sten

Liscio

composition

35% WO / 35% CV / 21% CO / 9% PA

abrasion

30.000 Martindale

lightfastness

4-6

firetest

US. Cal. Bull. 117-2013

Upon request, with treatment:

BS5852 part I

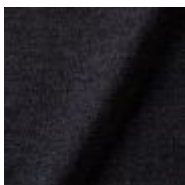

Liscio
Grigio Blu Scuro



Liscio
Grigio Blu

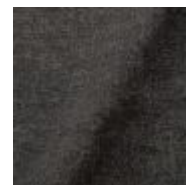

Liscio
Grigio Scuro

m o o o i[®]



Liscio
Muscio



Liscio
Argento



Liscio
Nebbia



Liscio
Perla



Liscio
Latte Scuro



Liscio
Latte

Solis

composition

2% PA 3% PC 30% PL 65% WO

abrasion

40.000 Martindale rubs, EN ISO 12947

lightfastness

Note 5, EN ISO 105-B02

firetest

EN 1021-1/2

US. Cal. Bull. 117-2013

Upon request, with treatment:

BS5852 part I

BS5852 crib 5



Solis
Crust



Solis
Dawn



Solis
Fog



Solis
Paper



Solis
Rain



Solis
Spencer



Solis
Sunset

Summit Melange

composition

20% WO / 5% PA / 15% PES
60% PES filling

abrasion

50.000 martindale

lightfastness 6

firetest

EN1021-1/2
US. Cal. Bull. 117-2013
BS5852 part I
DIN 4102-B2



Summit Melange
Flour

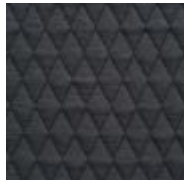

Summit Melange
Slate



Summit Melange
Dust



Summit Melange
Twig



Summit Melange
Lagoon

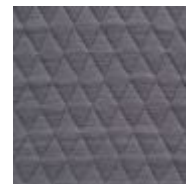

Summit Melange
Lavender

m o o o i[®]

Summit UNI

composition

22% wo, 2% pa, 14% pl, 62% pl filling

abrasion

50.000 martindale

lightfastness 5

firetest

EN1021 I&2

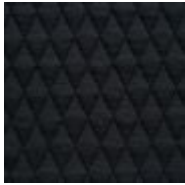

Summit UNI
Caviar



Summit UNI
Graphite



Summit UNI
Grass



Summit UNI
Linen

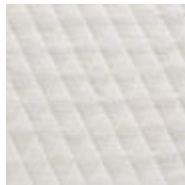

Summit UNI
Natural

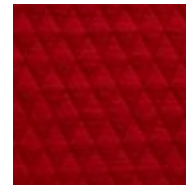

Summit UNI
Passion

m o o o i[®]

Trickle

composition

60% WO / 20% PES / 20% PA

abrasion

80.000 martindale

lightfastness 6

firetest

EN1021-1/2

US. Cal. Bull. 117-2013

BS5852 part1

DIN 4102-B2



Trickle
Flour



Trickle
Twig



Trickle
Peat



Trickle
Slate

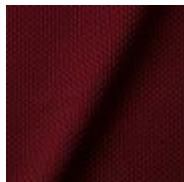

Trickle
Chili



Trickle
Lavender

Twill

composition

72% wo, 8% pa, 20% pl

abrasion

75.000 martindale

lightfastness 5

firetest

EN1021 I&2

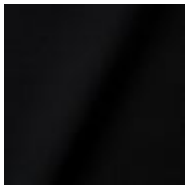

Twill
Caviar

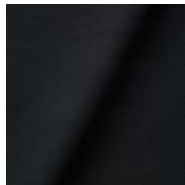

Twill
Graphite

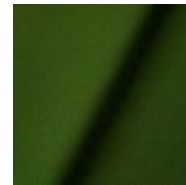

Twill
Grass



Twill
Linen



Twill
Natural



Twill
Passion

m o o o i[®]

Twill Melange

composition

60% WO / 20% PES / 20% PA

abrasion

80.000 martindale

lightfastness 6-7

firetest

EN1021-1/2

US. Cal. Bull. 117-2013

BS5852 part1

DIN 4102-B2

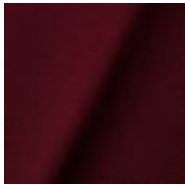

Twill Melange
Chili



Twill Melange
Dust



Twill Melange
Flour



Twill Melange
Lavender

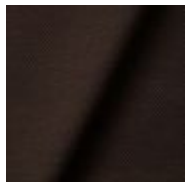

Twill Melange
Peat

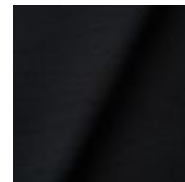

Twill Melange
Slate

Velour

composition

77% wo, 8% pa, 15% pl

abrasion

100.000 martindale

lightfastness 7

firetest

FR BS5852 0/1

EN1021 1&2



Velour
Coral



Velour
Stone



Velour
Moss

Vesper

composition

10% CO, 40% L, 10% PA, 10% PL, 30% VI

abrasion

40.000 Martindale rubs, EN ISO 12947

lightfastness

Note 5, EN ISO 105-B02

firetest

EN 1021-1/2

US. Cal. Bull. 117-2013

Upon request, with treatment:

BS5852 part I

BS5852 crib5

m o o o i[®]



Vesper
Aluminium



Vesper
Brass



Vesper
Bronze



Vesper
Nickel



Vesper
Silver

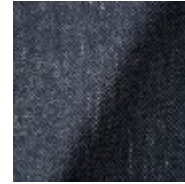

Vesper
Steel

Twill Summit Uni Composition

composition

Twill: 72% wo, 8% pa, 20% pl

Summit UNI: 22% wo, 2% pa, 14% pl, 62% pl filling

abrasion

Twill: 75.000 martindale

Summit Uni: 50.000 martindale

lightfastness 5

firetest

EN1021 I&2

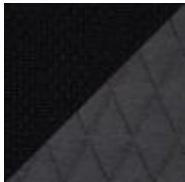

Caviar



Graphite

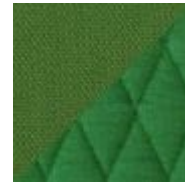

Grass



Linen



Natural



Passion

Cervino Leather

composition

100% aniline leather

Leather is a natural product, colours may vary from hide to hide.

firetest

EN1021 I&2



Cervino Leather
Anthracite



Cervino Leather
Cognac

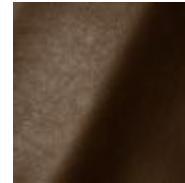

Cervino Leather
Mud

Arredo Leather

composition

100% semi aniline leather

Leather is a natural product, colours may vary from hide to hide.

firetest

EN1021 I&2



Arredo Leather
Black

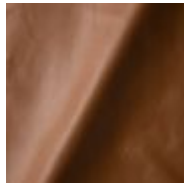

Arredo Leather
Brown

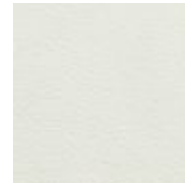

Arredo Leather
White



Kvadrat Fabrics

Kvadrat Fabrics

Selected Moooi products can be upholstered with a collection of Kvadrat fabrics. Kvadrat designs high-quality upholstery, in an extensive range of colours and textures.

Go to our Kvadrat fabrics page for a full overview of all fabric families you can choose from.



Dodo Pavone Jacquard

composition

12% CO 88% PL

abrasion

40.000 Martindale rubs, EN ISO 12947

lightfastness

Note 5, EN ISO 105-B02

firetest

US. Cal. Bull. 117-2013

Upon request, with treatment:

BS5852 part I



**Extinct Animals
Fabric Collection**
Dodo Pavone Jacquard



Bearded Leopard Jacquard

composition

77% VI / 15% PES / 7% CO / 1% PA

abrasion

15.000 Martindale rubs, EN ISO 12947

lightfastness

Note 4-6, EN ISO 105-B02

firetest

EN1021-1/2

Upon request and with treatment:

BS5852 part I



**Extinct Animals
Fabric Collection**
Bearded Leopard
Jacquard

Blushing Sloth Melange Mohair

composition

29% LANA / 24% LANA WM / 24% PES / 15% PA / 8% CO

abrasion

40.000 Martindale rubs, EN ISO 12947

lightfastness

Note 4-6, EN ISO 105-B02



**Extinct Animals
Fabric Collection**
Blushing Sloth Melange
Mohair

Blushing Sloth Woolly Mohair

composition

85% WV / 15% WM

abrasion

15.000 Martindale rubs, EN ISO 12947

lightfastness

Note 4-6, EN ISO 105-B02

firetest

EN1021-1/2

BS5852 part I



**Extinct Animals
Fabric Collection**

Blushing Sloth Woolly
Mohair

Calligraphy Bird Jacquard

composition

64% VI, 21% PES, 15% CO

abrasion

50.000 Martindale rubs, EN ISO 12947

lightfastness

Note 4-6, EN ISO 105-B02

firetest

Upon request, with treatment;
BS5852 part I

m o o o i[®]



Extinct Animals Fabric
Collection
Calligraphy Bird
Jacquard

The Silent Bison Velvet

composition

100% CO

abrasion

30.000 Martindale rubs, EN ISO 12947

lightfastness

Note 4-6, EN ISO 105-B02



Extinct Animals Fabric
Collection
The Silent Bison Velvet

Dwarf Rhino Crackle

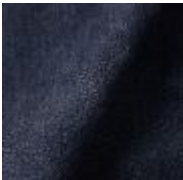

**Extinct Animals
Fabric Collection**
Dwarf Rhino Crackle

Armoured Boar Crackle

composition

100% cow hide

Type of leather

Pure aniline, nubuck finish



**Extinct Animals
Fabric Collection**
Armoured Boar Crackle

Armoured Boar Hairy

composition

100% cow skin

lightfastness

>3, ISO 105-B02:2004



**Extinct Animals
Fabric Collection**
Armoured Boar Hairy

m o o o i[®]

packaging

Bart Sofa, Daybed & Canape:

H 105 cm | 41.3"
W 250 cm | 98.4"
D 72 cm | 28.3"

Colli I

With packaging:
89 KG | 196 lb

Bart Sofa XL:

H 116 cm | 45.7"
W 306 cm | 120.5"
D 66 cm | 26.0"

Colli I

With packaging:
110 KG | 243 lb

Bart Armchair, Bart Canape Armchair:

H 102 cm | 40.2"
W 104 cm | 40.9"
D 63 cm | 24.8"

Colli I

KG | lb
With packaging:
39 KG | 86 lb

dimensions Bart Sofa & Bart Armchair

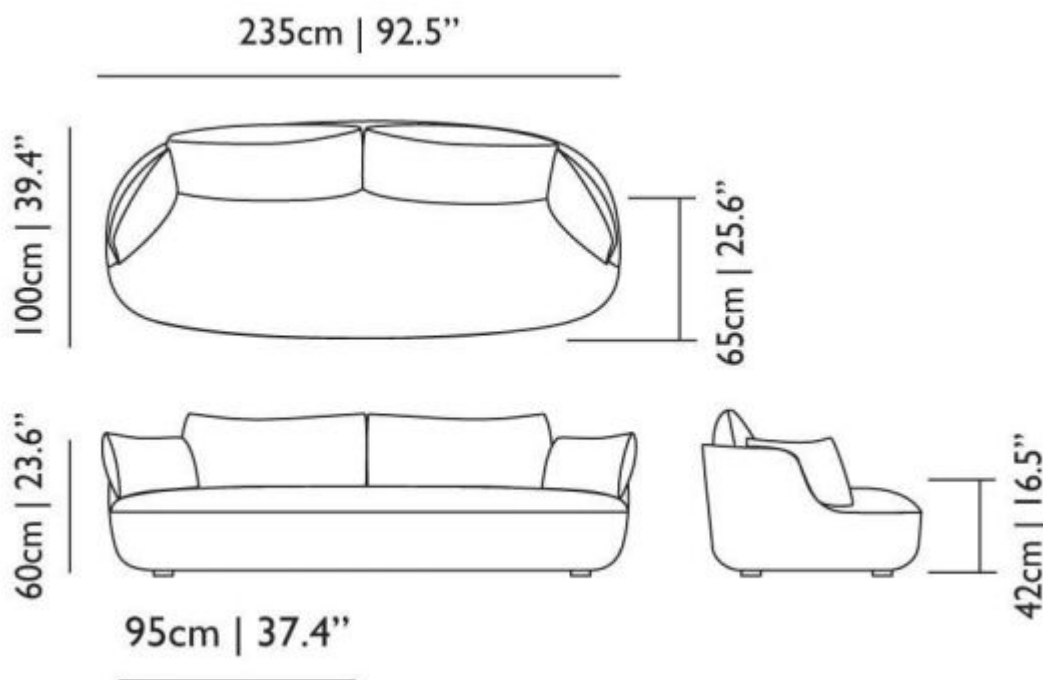

m o o o i

95cm | 37.4"

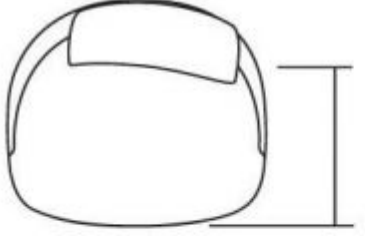

65cm | 25.6"

60cm | 23.6"

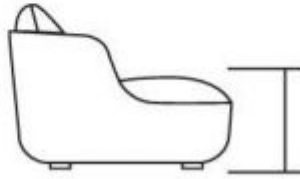
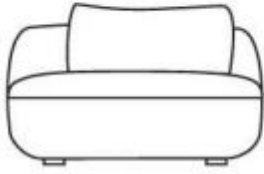

42cm | 16.5"